

Article number: 2314450687

Description: E+G polyamide wheel

RE.F8-125-FBL-N - Turning plate wo/brake in Zinc-plated steel

Measures

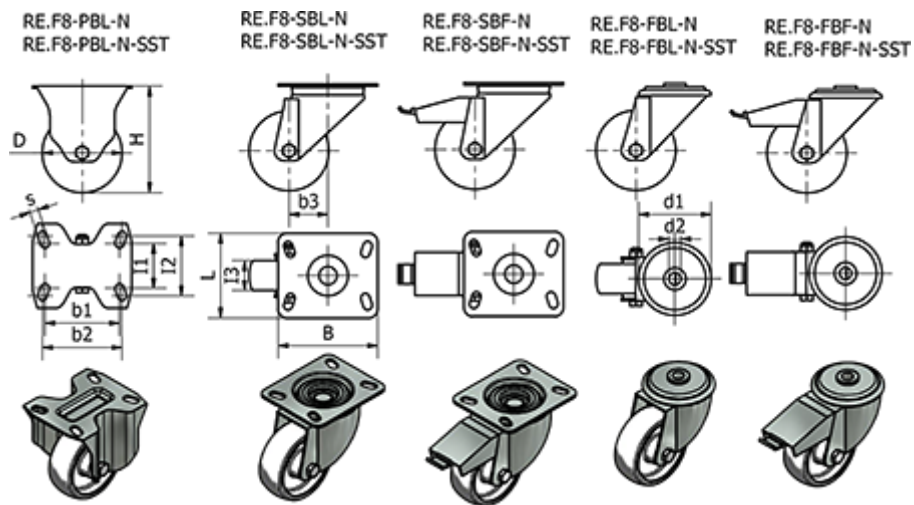

= -	d2	= 12	Rolling resistance (N)	= 2000	
B	=	Dynamic carrying capacity (N)	= 2200	s	=
b1	=	H	= 156	Type	= RE.F8-125-FBL-N
b2	=	l1	=	Wight (g)	= 850
b3	= 37	l2	=		
Code	= 450687	l3	= 38		
D	= 125	L	=		
d1	= 73	R	= -		